



# Farnell

TRANSISTORISED  
R.F. MILLIVOLTMETER  
TYPE TM6.

INSTRUCTION BOOK

FARNELL INSTRUMENTS LIMITED

TRANSISTORISED  
R.F. MILLIVOLTMETER  
TYPE TM6.

FARNELL INSTRUMENTS LIMITED,  
Sandbeck Way, WETHERBY, Yorkshire.

Telephone Wetherby  
0937 3541/6.

## CONTENTS.

	Page No.
GENERAL INFORMATION .. .. .	1
SPECIFICATION. .. .. .	2
ACCESSORIES .. .. .	3 & 4
OPERATING INSTRUCTIONS .. .. .	5
CIRCUIT DESCRIPTION .. .. .	6 & 7
PARTS LISTS .. .. .	8 - 11
CALIBRATION PROCEDURE. .. .. .	12
COMPONENT IDENTIFICATION C.B. NO. 1 .. .. .	13
COMPONENT IDENTIFICATION POTENTIOMETER CIRCUIT BOARD.. .. .	14
COMPONENT IDENTIFICATION POWER SUPPLY CIRCUIT BOARD.. .. .	15
CIRCUIT DIAGRAM .. .. .	16
ERRATA AND ADDENDA .. .. .	17

The TM-6 R.F. Millivoltmeter is a general purpose millivoltmeter of high sensitivity. The frequency range is 50 KHz to 1500 MHz with full scale deflection from 1mV r.m.s. to 3V r.m.s.

The readings on the 30 mV and lower ranges are very close to true r.m.s. This also applies to measurements of 3V and less when used with the X100 multiplier.

The full wave diode probe configuration reduces errors due to non-symmetry of the signal being measured.

The instrument is small in size, due to the use made of linear integrated circuits. All circuits including probe, are solid state for better reliability.

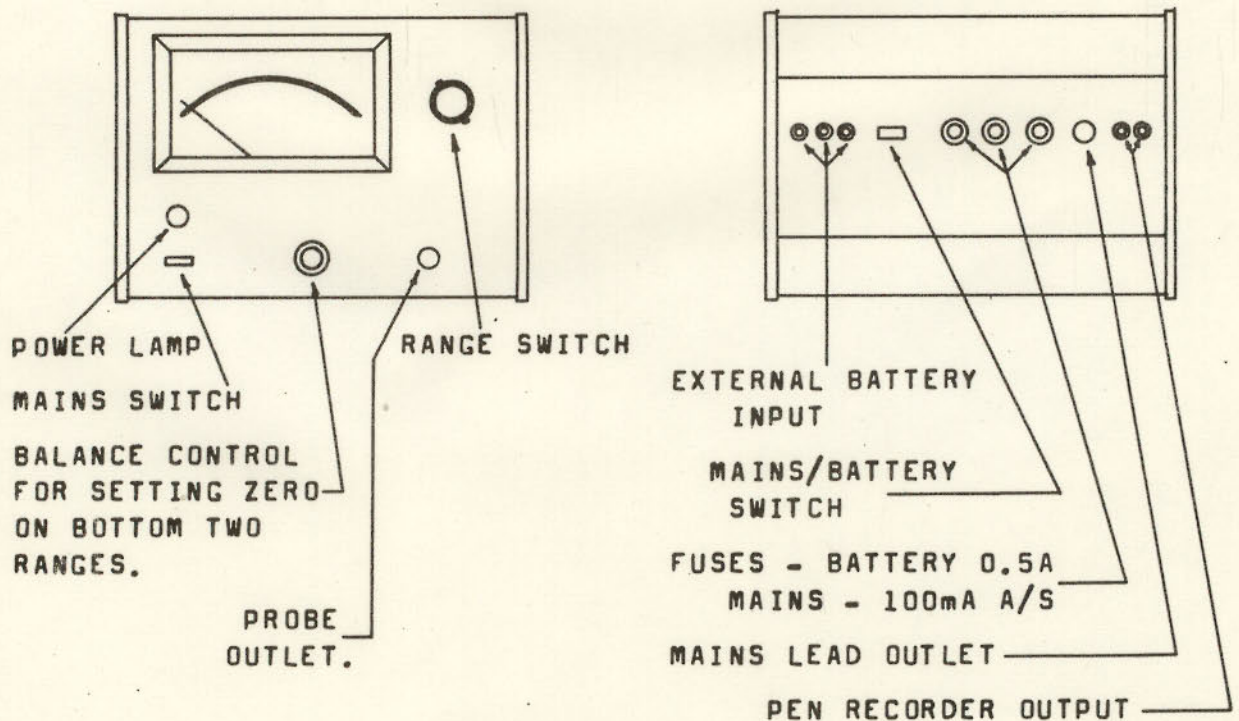

**Voltage Range:** 1 mV r.m.s. full scale to 3V r.m.s. full scale. Max. input 8V r.m.s. Max. d.c. to be applied to probe is 300V.

**Frequency Range:** 50 KHz to 1500 MHz giving a useful indication to 3000 MHz.

**Accuracy:** (10°C - 40°C) 1 mV and 3mV ranges  $\pm 5\%$  of full scale. Linearity  $\pm 5\%$  F.S.D. 10mV range and higher  $\pm 3\%$  of full scale. Linearity  $\pm 2\%$  of full scale. (200 KHz to 200 MHz.)

**Frequency Response:** With respect to 100 MHz:

50 KHz to 200 KHz +0, -0.4 dB  
 200 MHz to 500 MHz  $\pm 0.5$  dB  
 500 MHz to 1000 MHz  $\pm 1$ dB.  
 1000 MHz to 1500 MHz  $\pm 2$ dB

SPECIFICATION LIMIT

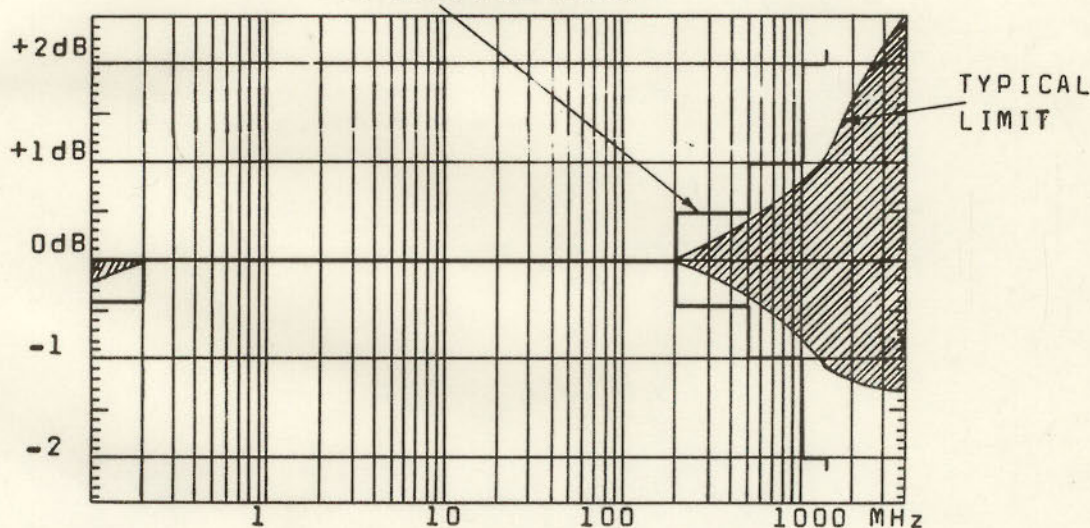

**NOTE:** The accuracy figure must be used in conjunction with the frequency response for frequencies other than between 200 KHz and 200 MHz.

**Input Resistance:** 150 K $\Omega$  at 1 MHz and 1V r.m.s.

**Input Capacitance:** 2.5 pF at 1 MHz and 1V r.m.s.

**Supplies:** 190V to 260V or 95V to 130V at 45 Hz to 500 Hz.  
 External batteries +18V to +24V & -18V to -24V.

**Dimensions:**

Height	Width	Depth (including handles).
With feet 6 <sup>3</sup> / <sub>8</sub>	8 <sup>5</sup> / <sub>8</sub>	9 <sup>7</sup> / <sub>8</sub>
162 m.m.	218 m.m.	251 m.m.

1. Earthing Clip - TM6/1.
2. 100 : 1 Multiplier (500 KHz to 500 MHz) - TM6/2.

## Accuracy:

0.5 MHz to 20 MHz :  $\pm 0.3$  dB.  
 20 MHz to 100 MHz :  $\pm 0.1$  dB.  
 100 MHz to 200 MHz  $\pm 0.3$  dB.  
 200 MHz to 300 MHz  $\pm 0.7$  dB.  
 300 MHz to 500 MHz  $\pm 1.5$  dB.

Input resistance            20 M $\Omega$  at 1 MHz.  
                                       1 M $\Omega$  at 50 MHz.  
                                       100 K $\Omega$  at 300 MHz.

Input Capacitance            2.5 pF.

Maximum Input:            300V r.m.s. up to 100 MHz above  
 100 MHz.

$$V_{\max} = \frac{3 \times 10^6}{f^2} \quad (f \text{ in MHz})$$

Peak voltage must not exceed 1000V whether a.c. or  
 d.c. or any combination.

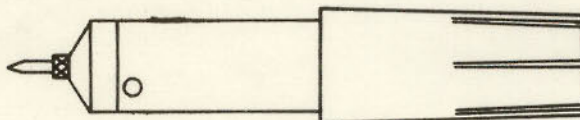

100:1 MULTIPLIER - TM6/2.

## (OPTIONAL)

3. Coaxial 'T' connector - TM6/3.  
 Return loss  $< -20$  dB at 1500 MHz when terminated in  
 50 $\Omega$ , with TM.6 probe plugged in side entry.
4. Probe to type 'N' adaptor TM6/4 (terminated) -  
 $1/4$ W, 50 $\Omega$ .

Return loss: <- 25 dB to 500 MHz.  
 <- 20 dB to 900 MHz.

5. Probe to type 'N' adaptor type TM6/5 (unterminated) as above but without load.
6. 50Ω load,  $\frac{1}{4}W$  - TM6/6, type 'N' plug termination.

Return loss <-25 dB to 1500 MHz.

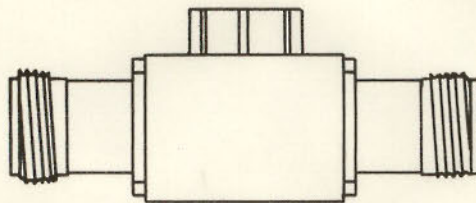

COAXIAL 'T' CONNECTOR  
 - TM6/3.

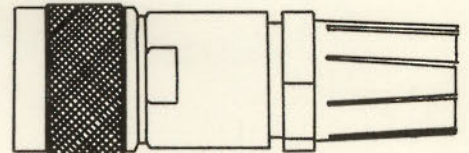

PROBE TO TYPE 'N' ADAPTOR  
 - TM6/4.

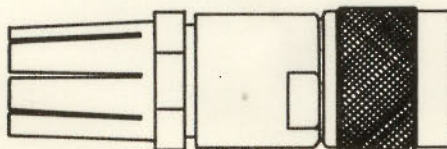

PROBE TO TYPE 'N' ADAPTOR  
 - TM6/5.

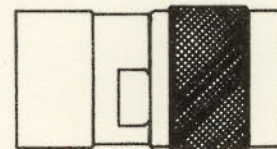

50Ω LOAD TYPE 'N'  
 - TM6/6.

### 1. Installation.

Fit mains plug: Line-Brown, Neutral-Blue and earth Yellow/Green.

Check that mains taps are set for the required mains voltage and that the correct fuse is fitted:

100mA for 190-260V input.  
200mA for 95-130V input.

Check that the mains/battery switch is in the 'MAINS' position.

Switch on and allow at least 5 minutes warm-up time. Best accuracy is obtained after 20 minutes.

### 2. Operation.

The instrument may now be used to measure voltages up to 3V r.m.s. For measurement of low levels, up to 10mV r.m.s., it is necessary to zero the meter by means of the balance control.

Care should be taken when zeroing the 1mV range as the balance control is quite coarse on this range and there is a time delay before the meter follows the adjustment. This is due to the fact that the thermal e.m.f. produced by the diodes is of a greater magnitude than the detected voltage due to the signal.

The sensitivity of the probe to spurious pick-up, especially mains-borne spikes, is very high, and it is advisable to use the adaptors to minimise this. To ensure best balance on the 1mV range, it is advisable to use a terminated adaptor to earth the probe tip. DO NOT RELY ON TOUCHING THE PROBE TIP TO THE CHASSIS.

To obtain the exact zero setting, it is necessary to first evaluate the typical peak-to-peak swing of the pointer by offsetting the zero. Then reduce the setting slowly until the pointer dwells on the electrical end stop (just below zero) for about 50% of the time. The peak deflection should correspond to half the peak-to-peak figure (linear scale) previously recorded. It may be necessary to readjust the zero for use on the 3mV range.

Random noise  $\pm$  2 small divisions on the 0-10 scale.

Impulse pick-up  $\pm$  7 small divisions on the 0-10 scale.

(The impulse figures may vary according to the electrical environment in which the instrument is used).



The probe consists of two diodes in a fullwave configuration which produce d.c. levels, on the two output leads, proportional to the positive and negative peaks of the waveform being measured.

After filtering, these two d.c. levels are applied to PR1 and PR2, photo-resistors which are made to conduct in an antiphase sequence by the photo-emitting diodes D12 and D13, producing a square-wave of peak to peak amplitude equal to the potential difference between the two d.c. levels.

To allow the diodes to operate at levels as low as 1mV r.m.s. it is necessary to run them at a very low current. This necessitates a very high input impedance to the first stage of the a.c. amplifier.

This is realised by the use of two f.e.t.'s (VT1 and VT2) as a long-tailed-pair pre-amplifier to the first integrated operational amplifier, OA1.

The d.c. feedback ensures a d.c. gain of unity for thermal stability, while the a.c. gain is controlled by R16 and the resistor selected by the range switch SA1.

The second amplifier is identical to the first with the exception of the high impedance pre-amplifier.

The output of the second a.c. amplifier is d.c. restored in a synchronous mode by f.e.t. VT.3 and fed into the lag circuit involving OA3. There is a preset resistor associated with each range, at the input of this stage, to allow calibration.

The d.c. output from this stage is fed into a diode function generator, incorporated in the feedback reference of OA5, which corrects for the diode law on all ranges except the 1mV range.

The meter is driven directly from the output of this stage.

The oscillator, controlling the operation of the photo-chopper, consists of an astable multivibrator circuit incorporating OA4.

The power supplies of +15V and -15V are obtained by means of a centre-tapped transformer and two fullwave rectifiers D4, D5, D6 and D7, and regulated by the series regulators VT. 6 and VT7.

The transformer primaries are connected in series for 190-260V operation and in parallel for 95-130V operation.

Two external batteries of 18-24V each may be used instead of the mains supply.

## PARTS LISTS

TM6

R1	Resistor	56Ω	NOMINAL	MULLARD MR30.
R2	Resistor	22M	±10%	DUBILIER BTT.
R3	Resistor	22M	±10%	DUBILIER BTT.
R4	Resistor	220K	± 2%	MULLARD MR30.
R5	Resistor	220K	± 2%	MULLARD MR30.
R6	Resistor	100M	±10%	DUBILIER BTT.
R7	Resistor	10K	± 2%	MULLARD MR30.
R8	Resistor	12K	± 2%	MULLARD MR30.
R9	Resistor	10K	± 2%	MULLARD MR30.
R10	Resistor	100K	± 2%	MULLARD MR30.
R11	Resistor	1.8K	± 2%	MULLARD MR30.
R12	Resistor	10K	± 2%	MULLARD MR30.
R13	Resistor	47K	±2%	MULLARD MR30.
R14	Resistor	100K	± 2%	MULLARD MR30.
R15	Resistor	1.5K	± 2%	MULLARD MR30.
R16	Resistor	1M	± 2%	MULLARD MR30.
R17	Resistor	220K	± 2%	MULLARD MR30.
R18	Resistor	820K	± 2%	MULLARD MR30.
R19	Resistor	1.2K	± 2%	MULLARD MR30.
R21	Resistor	47K	± 2%	MULLARD MR30.
R22	Resistor	1.8K	± 2%	MULLARD MR30.
R23	Resistor	10K	± 2%	MULLARD MR30.
R24	Resistor	1.5K	± 2%	MULLARD MR30.
R25	Resistor	100K	± 2%	MULLARD MR30.
R26	Resistor	39K	± 2%	MULLARD MR30.
R27	Resistor	100K	± 2%	MULLARD MR30.
R28	Resistor	560K	± 2%	MULLARD MR30.
R29	Resistor	1K	± 2%	MULLARD MR30.
R30	Resistor	1M	± 2%	MULLARD MR30.
R31	Resistor	1.2M	± 1% ± 100 P.P.M./°C.	WELWYN 4013.
R32	Resistor	4.7M	± 1% ± 100 P.P.M./°C.	WELWYN 4013.
R34	Resistor	1K	± 2%	MULLARD MR30.
R35	Resistor	1K	± 2%	MULLARD MR30.
R36	Resistor	270K	± 2%	MULLARD MR30.
R37	Resistor	100K	± 2%	MULLARD MR30.
R38	Resistor	10K	± 2%	MULLARD MR30.
R39	Resistor	10K	± 2%	MULLARD MR30.
R40	Resistor	180K	± 2%	MULLARD MR30.
R41	Resistor	5.6K	± 2%	MULLARD MR30.
R42	Resistor	2.2M	± 5%	DUBILIER BTT.
R45	Resistor	5.6K	± 2%	MULLARD MR30.
R46	Resistor	12K	± 2%	MULLARD MR30.
R47	Resistor	22K	± 2%	MULLARD MR30.
R48	Resistor	22K	± 2%	MULLARD MR30.
R49	Resistor	680Ω	± 2%	MULLARD MR30.

## PARTS LISTS

TM6

R50	Resistor	1K	± 2%	MULLARD MR30.
R51	Resistor	82 $\Omega$	± 2%	MULLARD MR30.
R52	Resistor	180K	± 2%	MULLARD MR30.
R54	Resistor	8.2K	± 2%	MULLARD MR30.
R55	Resistor	15K	± 2%	MULLARD MR30.
R56	Resistor	1K	± 2%	MULLARD MR30.
R57	Resistor	220 $\Omega$	± 5%	ELECTROSIL TR8.
R58	Resistor	8.2K	± 2%	MULLARD MR30.
R59	Resistor	220 $\Omega$	± 5%	ELECTROSIL TR8.
R60	Resistor	470 $\Omega$	± 2%	MULLARD MR30.
R61	Resistor	180 $\Omega$	± 2%	MULLARD MR30.
R62	Resistor	120 $\Omega$	± 2%	MULLARD MR30.
R63	Resistor	150 $\Omega$	± 2%	MULLARD MR30.
R64	Resistor	2.2K	± 2%	MULLARD MR30.
R65	Resistor	47K	± 2%	MULLARD MR30.
R66	Resistor	270K	± 2%	MULLARD MR30.
R67	Resistor	68K	± 2%	MULLARD MR30.
R68	Resistor	22K	± 2%	MULLARD MR30.
R69	Resistor	56K	± 2%	MULLARD MR30.
R70	Resistor	100K	± 2%	MULLARD MR30.
R71	Resistor	5.6K	± 2%	MULLARD MR30.
R72	Resistor	1K	± 2%	MULLARD MR30.
R73	Resistor	47K	± 2%	MULLARD MR30.
R74	Resistor	47K	± 2%	MULLARD MR30.
R75	Resistor	47K	± 2%	MULLARD MR30.
R77	Resistor	100K	± 2%	MULLARD MR30.
R78	Resistor	2.2K	± 2%	MULLARD MR30.
R79	Resistor	2.2K	± 2%	MULLARD MR30.
R80	Resistor	180K	± 2%	MULLARD MR30.
R81	Resistor	180 $\Omega$	± 2%	MULLARD MR30.
R82	Resistor	4.7K	± 5%	WELWYN W21.
R83	Resistor	4.7K	± 5%	WELWYN W21.
R84	Resistor	390K	± 2%	MULLARD MR30.
R85	Resistor	1K	± 2%	MULLARD MR30.
R86 - R90	SOT			MULLARD MR30.
C1	Capacitor	1000p	500V	ERIE 861/K7004
C2	Capacitor	1000p	500V	ERIE 861/K7004
C3	Capacitor	1000p	500V	ERIE 861/K7004
C4	Capacitor	0.1 $\mu$	30V	ERIE 811/T/30
C5	Capacitor	0.1 $\mu$	30V	ERIE 811/T/30
C6	Capacitor	4,700p	500V	ERIE 801/K7004
C7	Capacitor	4,700p	500V	ERIE 801/K7004
C8	Capacitor	10 $\mu$	15V	I.T.T. TAG 10/15
C9	Capacitor	220p	500V	ERIE 831/K120051
C10	Capacitor	47p	500V	ERIE 801/N470
C11	Capacitor	2000 $\mu$	16V	MULLARD C431 BR/E2000
C12	Capacitor	0.1 $\mu$	30V	ERIE 811/T/30

## PARTS LISTS

TM6

C13	Capacitor	2000 $\mu$	16V	MULLARD C431BR/F2000
C14	Capacitor	4,700p	500V	ERIE 801/K7004
C15	Capacitor	220p	500V	ERIE 831/K120051
C16	Capacitor	10 $\mu$	15V	J.T.T. TAG 10/15
C17	Capacitor	47p	500V	ERIE 801/N470
C18	Capacitor	0.1 $\mu$	30V	ERIE 811/T/30
C19	Capacitor	0.1 $\mu$	25V	ERIE 811/T/25

C22	Capacitor	500 $\mu$	40V	MULLARD C431/BR/G500
C23	Capacitor	500 $\mu$	40V	MULLARD C431/BR/G500
C24	Capacitor	1 $\mu$	160V	WIMA TFM
C25	Capacitor	4,700p	500V	ERIE 801/K7004
C26	Capacitor	220p	500V	ERIE 831/K120051

D1	Diode	A.E.I. CG91AH
D2	Diode	A.E.I. CG91AH
D3	Diode	Transitron IN695
D4	Diode	Motorola IN4003
D5	Diode	Motorola IN4003
D6	Diode	Motorola IN4003
D7	Diode	Motorola IN4003
D8	Diode	S.T.C. Zener ZF5.6
D9	Diode	S.T.C. Zener ZF5.6
D10	Diode	Texas Zener IS7150A
D11	Diode	Texas Zener IS7150A
D12	Diode	Fairchild Light Emitter FLD100
D13	Diode	Fairchild Light Emitter FLD100
D14	Diode	Texas IN914
D15	Diode	Texas IN914
D16	Diode	Texas IN914
D17	Diode	Texas IN914
D18	Diode	Texas IN914
D19	Diode	Motorola IN4003
D20	Diode	Motorola IN4003
D21	Diode	Texas IN914

OA1	Integrated Circuit	SGS $\mu$ A 709
OA2	Integrated Circuit	SGS $\mu$ A 709
OA3	Integrated Circuit	SGS $\mu$ A 741
OA4	Integrated Circuit	SGS $\mu$ A 741
OA5	Integrated Circuit	SGS $\mu$ A 741

VT1)	Transistor	Texas matched pair F.E.T.'s TIS70
VT2)		
VT3	Transistor	Texas F.E.T. 2N3819
VT4	Transistor	Ferranti ZTX502
VT5	Transistor	Ferranti ZTX303
VT6	Transistor	Motorola MJE520
VT7	Transistor	Motorola MJE370
VT8	Transistor	Ferranti ZTX502
VT9	Transistor	Ferranti ZTX502

RV1	Potentiometer	5K	Plessey Type M
RV2	Potentiometer	220K	Plessey MP
RV3	Potentiometer	220K	Plessey MP
RV4	Potentiometer	220K	Plessey MP
RV5	Potentiometer	220K	Plessey MP
RV6	Potentiometer	220K	Plessey MP
RV7	Potentiometer	220K	Plessey MP
RV8	Potentiometer	220K	Plessey MP
RV9	Potentiometer	220K	Plessey MP
RV10	Potentiometer	22K	Plessey MP
RV11	Potentiometer	10K	Plessey MP
RV12	Potentiometer	22K	Plessey MP
RV13	Potentiometer	56K	Plessey MP
RV14	Potentiometer	56K	Plessey MP
RV15	Potentiometer	56K	Plessey MP

PR1	Photocell	Teknis VT21M
PR2	Photocell	Teknis VT21M

F1	Fuse	100mA A/S Beswick for 240V or 200mA A/S for 120V.
F2	Fuse	500mA Beswick.
F3	Fuse	500mA Beswick.

LP1	Lamp 24V Red	Guest International LS7-GT
-----	--------------	----------------------------

M1	Meter	100 $\mu$ A movement	Sifam Clarity Focus SP3739/2, SP3740/2
----	-------	----------------------	---

Input frequency = 100MHz.

1. Set range to 100mV & adjust RV6 for full-scale reading, RV15 for 1/3 full-scale and RV12 for zero on the 30mV range. (R88 is selected to give zero on 100mV range when RV12 has been adjusted to give zero on 30mV range).  
  
Adjust RV5 for full-scale and RV14 for 1/3 full-scale on the 30mV range.  
  
Re-check to zero settings.
2. Adjust balance control for zero on the 1mV range and adjust RV2 for full-scale setting.
3. Set 3mV range zero point with RV10 and adjust RV3 for full-scale setting. Repeat until both settings are correct.
4. Set full-scale on the 10mV range with RV4 and 1/3 full-scale with RV3. Repeat until both readings are correct. Adjust zero point with RV11. Re-check 1/3 full-scale.
5. Check 80mV and 100mV full-scale, 1/3 full-scale and zero settings.
6. Set full-scale on the 3V range with RV9 and 1/3 full-scale with RV18.
7. Set full-scale on the 1V range with RV8 and 1/3 full-scale with RV17.
8. Set full-scale on the 300mV range with RV7 and 1/3 full-scale with RV16.
9. Select a value of R89 for zero on the 300mV range and R90 for zero on the 1V range.

N.B. RE-CALIBRATION SHOULD NOT REQUIRE REPLACEMENT OF THE SELECTED RESISTORS.

ERRATA AND ADDENDA

ALTERNATIVE COMPONENTS TO THOSE LISTED ON CIRCUIT  
DIAGRAM MAY BE USED IN THE EVENT OF SUPPLY DIFFICULTIES.  
MAJOR CHANGES TO THE DESIGN OR MANUAL ARE LISTED BELOW:-



DRAWING No.	R	1	2	3, 19	4, 5	40	6	7, 8, 9	11, 10, 12, 13	14, 15, 16, 17, 18	21	22	23	24, 25, 26, 27, 34, 28	30, 31, 32, 29, 36, 35,	37	38, 39, 84	41	42	45	46	R				
2 - 5757	R	51	52, 54	55	56	57	58	59	60, 61, 62, 63, 64, 66, 70, 93, 67, 74,	65, 71, 69, 72, 73, 88, 89	85, 90	86	87, 92, 91	75	77	78	79	80	19	25	C					
USED ON	C	1, 24	2	3	4	5	6	7, 8	9, 10	12, 11	13	14	15	16, 17, 18	3	VT										
	VT	1, 2																			1, 8	2	9	MISC.		
	MISC.	D1, D2	OA4	PR1, PR2	D12, D13	OA1	D14, D15	SA1, D16	RV20, OA2, RV10, 13, 11	RV14, 12	RV15	RV16	RV17	D3	RV19, RV1, 2, 3, 4, 5, 6, 7, 8, 9	OA5	S3	OA3	M1	D17, D18, D21	MISC.					

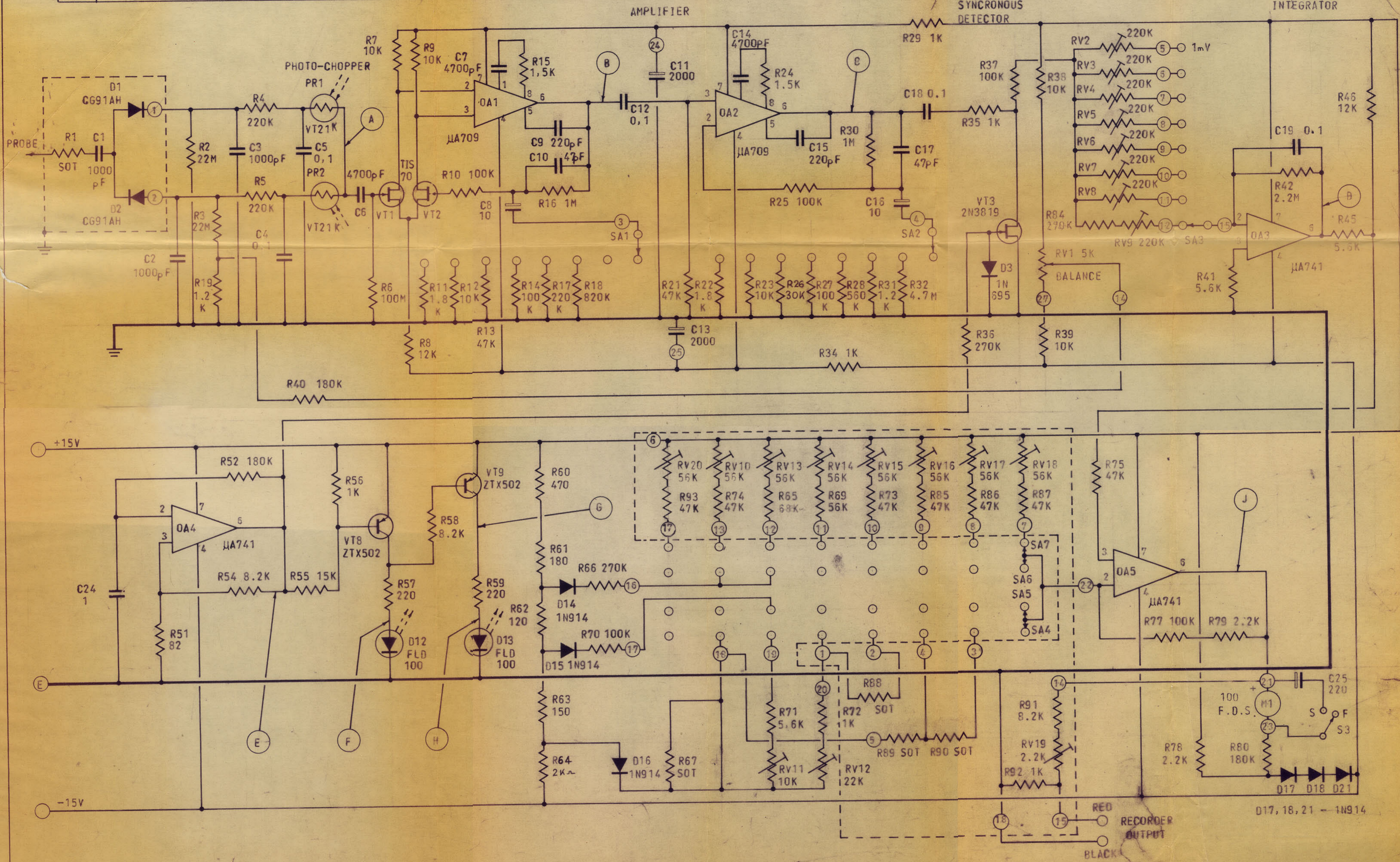

TRACED	5	28.7.71	Q980	11	14-8-74	Q3119
	4	23.6.71	Q942	10	3.6.74	Q2995
CHECKED	3	27.4.71	Q842	9	20-12-73	Q2700
	2	21.4.72	Q822	8	16-5-73	Q1851
DRAWN	ISSUE	DATE	MOD. No.	7	27.11.72	Q1719
		11.12.70	6	11.2.72	Q1242	

ALL RESISTOR VALUES IN OHMS UNLESS STATED OTHERWISE  
 ALL CAPACITOR VALUES IN MICRO-ARADS UNLESS STATED OTHERWISE  
 INDICATES CIRCUIT BOARD

TOLERANCES	PROTECTIVE FINISH	NOTE: REMOVE ALL BURRS AND SHARP EDGES
MATERIAL		
SCALE:	DIMENSIONS IN M.M.	

**FARNELL INSTRUMENTS LTD. WETHERBY, YORKS.**  
 TITLE: CIRCUIT DIAGRAM  
 P.F. MILLIVOLTMETER  
 DRAWING No. 2 - 5757  
 SHEET 2 OF 2 SHEETS

USED ON

DRG. No. 3-5757

R		82	83	47, 48	55, 49, 94	96	50	31	R
C		23	22			27		28	C
VT						4, 7			VT
MISC	SB1, SB2	T1	D2 01904, 5, 6, 7	F1	SC1	0A6, 0A7	D9	D8	MISC

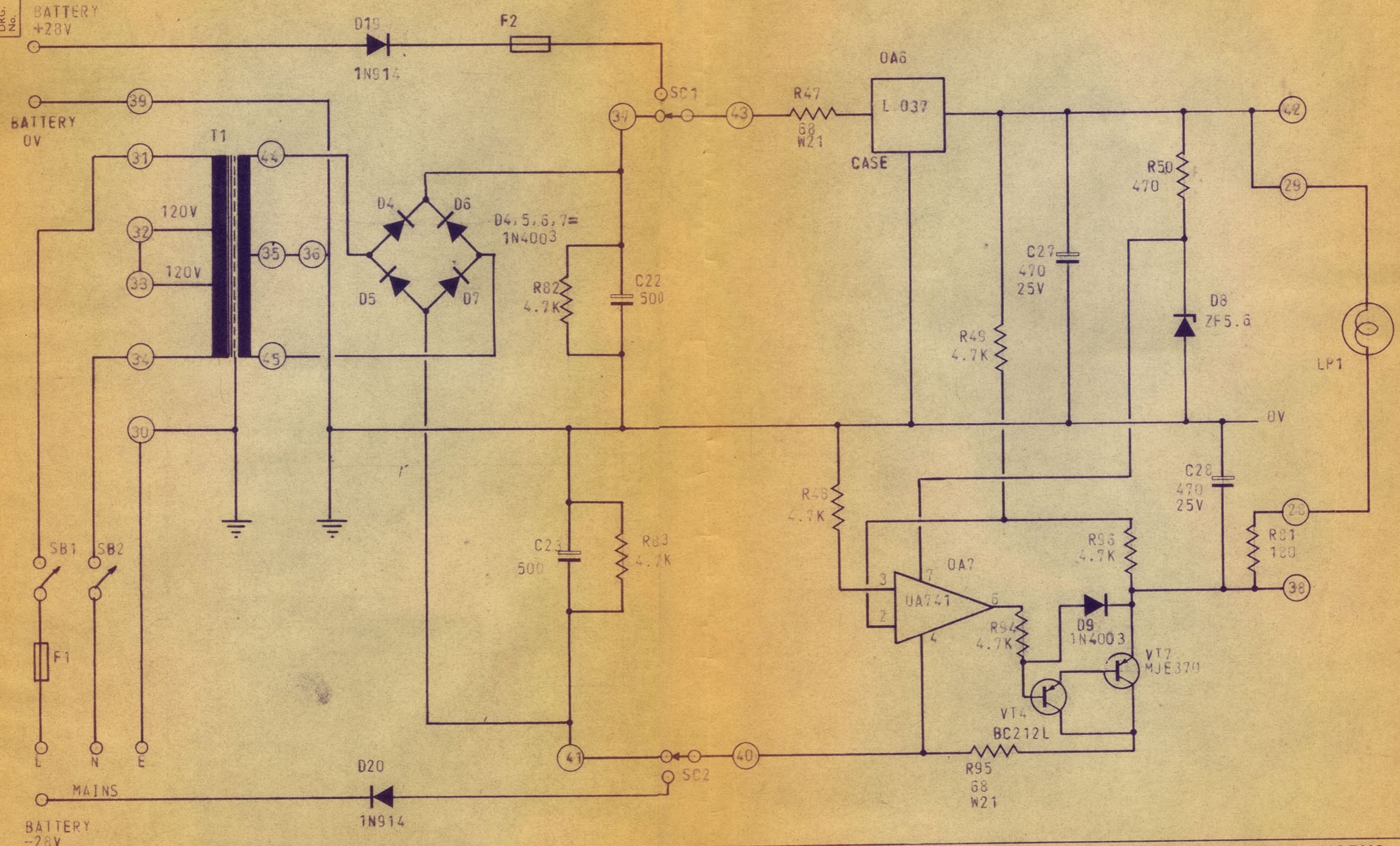

NOTE :-  
 CAPACITOR VALUES GIVEN IN µF.  
 RESISTOR VALUES IN Ω  
 ② REFERS TO CCT. BD,  
 PIN CONNECTION Nos.

FARNELL INSTRUMENTS LTD. WETHERBY, YORKS.

TRACED									
CHECKED									
DRAWN	BG	ISS.	DATE	MOD. No.					
		2	15.8.77						

CIRCUIT DIAGRAM  
 POWER SUPPLY  
 TM6

DRAWING No.  
 3-5757  
 SHEET 1 OF 2 SHEETS

01937 581961

FARNELL INSTRUMENTS LIMITED · SANDBECK WAY · WETHERBY · YORKSHIRE LS22 4DH · TELEPHONE 0937 3541