

A large meter with a 6 inch mirror backed scale enables measurements to be quickly and accurately made. A centre zero facility allows the instrument to be used as a high impedance galvanometer or null detector with a sensitivity of up to 50 μ V or 5 nA per division.

The fully floating input can be earthed and has a common mode rejection factor of up to 90 dB. Input resistance is 10 M Ω on the AC mV range and better than 100 M Ω on all other ranges. The instrument is overload protected up to 1700 V on most voltage ranges and is similarly protected on the current and resistance ranges.

An unusual feature of the FET Multimeter when used as an ohmmeter is that an alternative low level test voltage (24 mV) is available to allow measurement to be made in solid-state circuits without 'turning on' the devices.

The TF 2650 FET Multimeter has a comprehensive range of accessories which include an RF probe (1000 MHz), RF voltage divider (500 V), co-axial T connector (SWR 1.2:1, 1000 MHz) and a peak-to-peak probe to extend the a.c. measurement range, a high voltage probe (50 kV) and a current shunt (150 A) to extend the d.c. and a.c. ranges and also a temperature probe covering the range -150°C to +500°C.

The FET Multimeter is therefore an extremely versatile portable general purpose meter which coupled with its accuracy and low cost provides an instrument equally suitable for laboratory, education and general service applications.

12 DATA SUMMARY

MEASUREMENT RANGES

	DC and AC Voltage, DC and AC Current, Resistance, dBm (referenced to 1 mW) and optional temperature range.
Mode and range selection	Six push-button switches plus 25 position rotary switch.

DISPLAY

Voltage, current and temperature scales	150 mm (6 inch) mirror backed scale. Two black linear scales calibrated 0 to 5 and 0 to 15.
Resistance scale	Green, calibrated 0 to 1000.
dBm scale	Red, calibrated -20 to +6.
Additional scales	Centre Zero scale and battery supply voltage level indicator.

DC Voltage Measurement

Ranges	1.5, 5, 15, 50, 150, 500 mV, 1.5, 5, 15, 50, 150, 500 and 1500 V full scale. (The optional High Voltage Probe Type 54451-081C extends the range to 50 kV).
Accuracy	±1.5% of f. s. d.
Input impedance	100 M Ω

AC Voltage Measurement

Ranges	1.5, 5, 15, 50, 150, 500 mV, 1.5, 5, 15, 50, 150, 500, 1500 V full scale. (The optional High Voltage Probe Type 54451-081C extends the range to 30 kV RMS).
Frequency range	10 Hz to 20 kHz (The optional RF Detector Probe Type 54451-091E extends the fre- quency range to 1 GHz).
Accuracy	±1.5% of f. s. d. except on the 1.5 mV range where the accuracy is additionally:- ±1.5% of reading from 30 Hz to 10 kHz, ±3% of reading from 10 Hz to 30 Hz and from 10 kHz to 20 kHz.
Input impedance	10 M Ω in parallel with approx. 60 pF on 1.5 to 150 mV ranges. 100 M Ω in parallel with approx. 20 pF on 500 mV to 1500 V ranges.

DC Current Measurement

Ranges	0.15, 1.5, 15 μ A, 0.15, 1.5, 15 mA, 0.15, 1.5 A full scale. (The optional Current Shunt Type 54461-021Z extends the range to 150 A).
Accuracy	±1.5% of f. s. d.
Input voltage drop	5 or 50 mV (nominal) depending on range selected and on input current level.

AC Current Measurement

Ranges	0.15, 1.5, 15 μ A, 0.15, 1.5, 15 mA, 0.15, 1.5 A full-scale. (The optional Current Shunt Type 54461-021Z extends the range to 150 A).
Frequency range	10 Hz to 20 kHz on 15 μ A range and above 10 Hz to 1 kHz on 0.15 and 1.5 μ A ranges
Accuracy	$\pm 1.5\%$ of f. s. d. and additionally :- $\pm 3\%$ of reading from 10 Hz to 30 Hz. $\pm 1.5\%$ of reading from 30 Hz to 20 kHz.

Resistance Measurement

Ranges	x 10 : 100 Ω mid-scale, 10 k Ω full-scale x 1k : 10 k Ω mid-scale, 1 M Ω full-scale x 100 k : 1 M Ω mid-scale, 100 M Ω full-scale. x 10 M : 100 M Ω mid-scale, 10,000 M Ω full-scale.
Accuracy	$\pm 5\%$ at mid-scale.
Test voltage on input terminals	24 mV on x10 range, 1.2 V on other ranges.

dBm Measurement

Range	-80 dB to +66 dB in 13 steps.
Meter scale	-20 to +6 dB (0 dB = 1 mW or 0.775 V. into 600 Ω).
Accuracy	$\pm 1.5\%$ of f. s. d. except on -60 dB range where the accuracy is additionally :- $\pm 1.5\%$ of reading from 30 Hz to 10 kHz $\pm 3\%$ of reading from 10 Hz to 30 Hz and from 10 kHz to 20 kHz.

Temperature Measurement

Using the optional Temperature Probe
Type 54451-131Y temperatures in the
range 0° to +500°C can be measured to an
accuracy of $\pm 1.5\%$ f. s. d. $\pm 2^\circ\text{C}$. (See Fig. 2.8.)

Temperatures in the range 0° to -150°C
can be measured at reduced accuracy.

CENTRE ZERO SENSITIVITY

Up to 50 μ V or 5nA per division (nominal).

STABILITY

Zero stability (at constant temperature)	Zero drift less than 40 μV in eight hours.
Temperature coefficient	Less than 15 μV per $^{\circ}\text{C}$ from 0° to $+50^{\circ}\text{C}$ (specification accuracy maintained between $+5^{\circ}\text{C}$ to $+40^{\circ}\text{C}$).
Internal noise	Less than 30 μV with 100 $\text{k}\Omega$ series resistor.

OVERLOAD PROTECTION

Short term overload (less than 1 second)	1700 V on all DC and AC ranges.
Continuous overload	170 V on 1.5 mV to 150 mV ranges 1700 V on remaining ranges.
Maximum voltage between common line and earth	1000 V.

POWER REQUIREMENTS

Internal d. c.	12 to 18 V, 4 mA approximately. Provided by 12 batteries of 1.5 V (IEC size R6), housed in battery cassette supplied.
AC supply	115 V or 230 V $\pm 15\%$, 40 to 60 Hz or 400 Hz, 5 VA using optional Mains Power Supply Unit Type 54441-011T.

DIMENSIONS AND WEIGHT

Height	Width	Depth	Weight
200 mm (7 $\frac{1}{4}$ in)	192 mm (6 $\frac{1}{2}$ in)	105 mm (3 $\frac{1}{2}$ in)	2.5 kg. (5.5 lb)

(Includes leather carrying case)

1.3 ACCESSORIES

SUPPLIED

Co-axial cable (1.5 metres) terminated in BNC plug and banana plugs.
Leather carrying case
Instruction Manual
Red and Black insulated crocodile clips
Red and Black insulated 105 mm probe.

OPTIONAL ACCESSORIES

150 mm Clip-on flexible test probe - Red Type 54451-141S
Black Type 54451-151C

Note. - The accuracy specification quoted below for the following accessories is the total accuracy of the TF 2650 and accessory combination.

CO-AXIAL T CONNECTOR Type 54311-051G

For use with 50 Ω co-axial systems.

Frequency range 1 kHz to 1000 MHz.
VSWR (when fitted with RF Probe) \leq 1.2:1 at 1000 MHz.
Connector Type N sockets (50 Ω).

MAINS POWER SUPPLY UNIT Type 54441-011T

Replaces battery cassette.

Power requirements 115 V or 230 V \pm 15% (selected by slide switch).
40 to 60 Hz or 400 Hz \pm 10% 5 VA.

HIGH VOLTAGE PROBE Type 54451-081C

Voltage ratio Nominally 1000:1.
Additional measurement ranges 1.5, 5, 15, 50 kV f.s.d. DC or AC (Max peak voltage at probe input 50 kV).
Accuracy \pm 5% of reading \pm 1.5% of f.s.d.
Frequency range DC and 40 to 60 Hz.

RF DETECTOR PROBE Type 54451-091E

Compatible with Co-axial T Connector.

Additional measurement capability Frequency range extended to 1 GHz.
Measurement ranges 1.5, 5, 15 V f.s.d.
Accuracy \pm 5% f.s.d. on 5 V and 15 V ranges.
(at 10 kHz) \pm 7.5% f.s.d. on 1.5 V range.
Frequency response Relative to response at 10 kHz.
(when used with Coaxial-T-Connector into 50 Ω load) \pm 1 dB 1 kHz to 100 MHz.
 \pm 3 dB 100 MHz to 700 MHz.
 \pm 3 dB 700 MHz to 1000 MHz.
Input impedance Approximately 300 k Ω in parallel with 2.5 pF measured at a frequency of 1 kHz.

PEAK-TO-PEAK PROBE

Type 54451-101L

Additional measurement ranges	5, 15, 50, 150, 500 and 1500 V p-p.
Maximum input voltage	1500 V peak-to-peak.
Accuracy (at 1 kHz)	±5% f.s.d. on 50 V to 1500 V ranges. ±10% f.s.d. on 15 V range. ±20% f.s.d. on 5 V range.
Frequency response (relative to 1 kHz)	±0.5 dB 30 Hz to 1 MHz. ±3 dB 10 Hz to 10 MHz.

RF VOLTAGE DIVIDER

Type 54451-111D

For use with R.F. Detector Probe
Type 54451-091E.

Additional measurement ranges	150 and 500 V f.s.d.
Division ratio (when used R.F. Detector Probe)	Nominally 100:1.
Frequency range	10 kHz to 10 MHz.
Maximum input volts	500 V peak.

TEMPERATURE PROBE

Type 54451-131Y

Additional measurement capability	-150 ^o to +500 ^o C in 5 ranges 0 to -150 ^o C 0 to -50 ^o C 0 to +50 ^o C 0 to +150 ^o C 0 to +500 ^o C
Accuracy	±2 ^o C ±1.5% of f.s.d. from 0 ^o to +500 ^o C. Below 0 ^o C ranges 0 to -50 ^o C and 0 to -150 ^o C may be used with reduced accuracy. (See Fig. 2.8.)

CURRENT SHUNT

Type 54461-021Z

Additional measurement ranges	5, 15, 50, 150 A f.s.d. AC and DC.
Accuracy	±3% f.s.d. at DC and between 30 Hz and 500 Hz. ±5% f.s.d. 500 Hz to 1 kHz.
Shunt resistance	Nominally 1 mΩ.
Maximum measurement duration	30 seconds on 50 and 150 A range.

2.1 INSTALLATION

The TF 2650 FET Multimeter is supplied ready for use with internal batteries fitted. Standard accessories include an input lead and a leather carrying case.

The carrying case is designed to allow measurements to be made without removing the unit. The FET Multimeter is therefore ideally suited for either field or bench use. Where prolonged bench use is anticipated the carrying case can be removed and the multimeter used either face up on its four rubber feet or in the tilted position by utilising the carrying handle as a tilt stand.

The FET Multimeter is housed in a high impact thermo-plastic case. Graphite lacquer is internally deposited on the case thus shielding the circuit from extraneous interference.

A banana socket on the front panel allows this shield and the 'low' side of the input terminal to be earthed.

The FET Multimeter can be used for measurement of non-earthed sources. In this mode it is essential that the multimeter front panel earth is not connected and that the following precautions are applied.

WARNING

Personal safety must be considered in view of the possible shock hazard due to the non-grounded input potential, in any case the maximum voltage between the outer casing of the BNC input socket and earth must not exceed 1000 volts.

2.1.1 Battery Unit Power Supply

Power is derived from a removable battery unit (B1) containing 12 x 1.5 V Varta 280 batteries (14.5 ϕ x 50.5 mm) or from the optional Mains Power Unit Type 54441-011.

Assuming normal daily use the batteries will provide from 250 to 700 hours operation dependant upon the type of battery used. When mercury or direct equivalent type batteries are fitted the equivalent of one years' full service can be expected. For battery replacement see Chapter 4.5.

A single battery (B2) providing voltage for resistance measurement is located beneath the battery unit. A mercury cell used for this function should provide

service for several years operation.

CAUTION

Damage to the instrument can result if the batteries are allowed to over-discharge. Therefore the Battery Check should be carried out every week and a visual check of the batteries made monthly to ensure that the electrolytic is not leaking. (See Chapter 4.5).

Permanent damage will result if the batteries are not replaced according to the polarity markings on the battery receptacle.

2.1.2 Mains Power Supply Unit Type 54441-011

The Mains Power Supply Unit is an optional accessory intended for use with 100-130/200-260 V 40-60/400 Hz AC supplies. The power supply unit physically replaces the battery unit. Installation consists simply of removing the battery box by releasing the two screws located on the rear of the instrument, withdrawing the complete battery unit and substituting the Mains Power Supply Unit.

Note - The single battery B2 should not be removed.

2.2 OPERATION

Front panel controls providing 64 measurement ranges, consist of 5 push-button switches and a 25-way rotary switch, ON/OFF and battery check push buttons plus calibration controls designated ZERO R and ZERO DC.

The 150 mm scale length meter has six scales. The top scale is specifically for resistance measurement and is coloured green. Below are two linear scales with 5 and 15 full scale units for measurement of temperature, DC and AC volts and current. The next scale is calibrated from -20 dBm to +6 dBm and is coloured red. Finally the bottom scales consist of a centre zero scale and a battery check position.

2.2.1 Preparation for Use

Proceed as follows :-

- (i) Ensure that the instrument is switched off and check the mechanical zero of the meter adjusting the screw immediately above the range switch if necessary.
- (ii) Check that the correct power supply is connected and that it is operating satisfactorily (a) when using the internal battery supply select BATT push button and check that the meter indicates BATT OK. (b) When using the Type 54441-011 PSU ensure that the 115/230 V switch located on the rear of the unit is set to the correct supply voltage. Verification of the correct function of the PSU can be easily made by using the battery check facility.

- (iii) Connect the input lead to the BNC connector and carry out the following meter zero procedure.

2.2.2 Set Zero

Prior to any measurement the FET Multimeter should be checked and if necessary, zeroed as follows:-

- (i) Select +ve push button
- (ii) Select 1.5 mV on range switch
- (iii) Select ON push button
- (iv) Short circuit test leads
- (v) Rotate the 10-turn ZERO DC front panel control until pointer indicates zero on the DC scale.

2.2.3 Centre Zero Mode

In this mode the FET Multimeter will operate as a current or voltage null indicator. Proceed as follows:-

- (i) Select the  push button
- (ii) Select the 1.5 mV range
- (iii) Short circuit test leads and check centre zero. If necessary adjust potentiometer R63 located through the right side wall of the instrument cover. Adjustment should only be necessary upon initial receipt of the instrument or following battery replacement.
- (iv) Connect test leads to the source and select the appropriate voltage or current range.
- (v) By progressively selecting the next lower range a null indication with a sensitivity of up to 50 μ V or 5 nA per division is achieved.

2.2.4 Input Polarity Select

With the +ve push button selected, a positive voltage applied to the centre conductor of the input socket will deflect the pointer clockwise. Selection of the -ve push button will reverse the direction of the pointer movement.

When making resistance measurement the polarity of the voltage applied to the unknown resistor (via the input socket centre conductor) will be as indicated by the front panel marking adjacent to the polarity select push buttons.

WARNING

When measuring DC voltages above 150 V it is strongly recommended that the 105 mm probes be used and not the insulated crocodile clips.

Measurement of DC voltage up to 1500 V is made as follows :-

- (i) Check zero
- (ii) Select required voltage range
- (iii) Select appropriate input polarity, +ve or -ve push button
- (iv) Connect test lead to voltage source being measured.

Measurement of voltages in excess of 1500 V can be made by utilising the High Voltage Probe (Type 54451-081) which is available as an optional accessory. (See Chapter 2.3 (a)).

SERIES MODE REJECTION

On all DC voltage measurement ranges provision is made for the attenuation of spurious signals. A typical attenuation characteristic curve is shown below

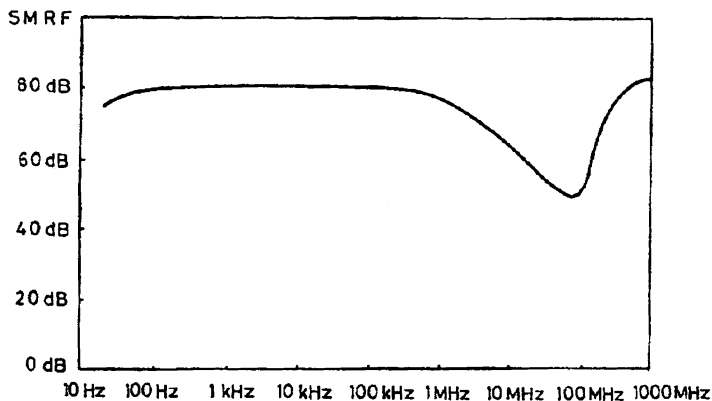

Fig. 2.1 Series Mode Rejection Response

SMRF - Series Mode Rejection Factor

$$\text{SMRF (dB)} = 20 \log \frac{\text{VAC}}{\text{VDC}}$$

Where VAC = voltage of superimposed AC signal causing 2% (f. s. d.) change in meter reading

VDC = value of DC voltage that would cause the same change in meter reading as VAC.

2.2.6 Low Frequency Voltage Measurement

WARNING

When measuring AC voltages above 150 V it is strongly recommended that the 105 mm probes be used and not the insulated crocodile clips.

Measurement of AC voltages up to 1500 V within the frequency range 10 Hz to 20 kHz is made as follows :-

- (i) Check zero
- (ii) Select required voltage range
- (iii) Select LF push button
- (iv) Connect test lead to the voltage being measured

Typical frequency response curves for measurement of voltages in the range 1.5 mV - 150 mV and 500 mV - 1500 V are shown in Fig. 2. 2.

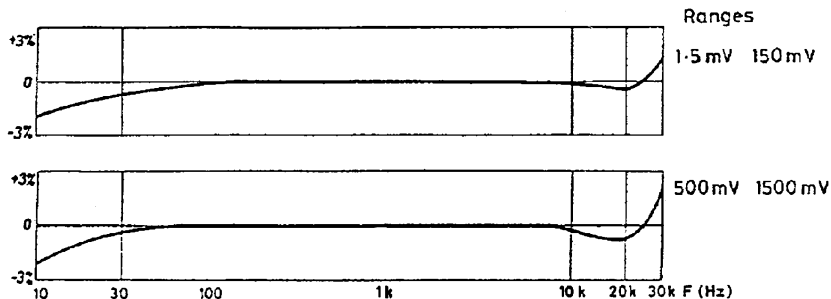

Fig. 2.2 LF Voltage Measurement Response

Voltages in excess of 1500 V can be measured using the optional accessory Type 54451-081 High Voltage Probe in which case frequency response is reduced to 40 Hz to 60 Hz with 5% accuracy (see Chapter 2.3(a)).

Peak to peak measurement can be made using the optional accessory Type 54451-101 Probe. Measurement procedure is the same as outlined above except in that the +ve push button is selected instead of the LF push button. (See Chapter 2.3(e)).

NOTE

The FET Multimeter has a very high input resistance and when switched to its more sensitive ranges stray signal pick-up may occur. The small meter deflection that results will not affect the accuracy of the instrument when correctly terminated.

2.2.7 High Frequency Voltage Measurement

A number of optional accessories are available (see Chapter 2.3) to extend the measurement capability of the FET Multimeter into the HF, VHF and UHF spectrum as follows:-

(a) The Type 54451-091 RF Probe extends the frequency coverage from 10 kHz to 1000 MHz using ranges 1.5 V, 5 V and 15 V only. Maximum voltage is limited to 15 V RMS and the DC component should not exceed 250 volts.

(b) The Type 54451-111 RF Voltage Divider used in conjunction with the RF Probe allows voltage measurement of up to 500 V RMS on ranges 1.5 V and 5 V f. s. d. only. Division ratio 100:1.

(c) The Type 54311-051 Co-axial T Connector should be used with the RF Probe to ensure minimum VSWR.

(d) The Type 54451-101 Peak to Peak Probe enables peak measurements to be made on ranges 5 to 1500 volts f. s. d. only.

For high frequency voltage measurement proceed as follows:-

- (i) Set zero
- (ii) Select required voltage range
- (iii) Select the HF push button
- (iv) Connect the RF Probe BNC plug to the front panel socket and the probe either directly to the source or via the appropriate accessory as indicated above.

Note:- If the Peak to Peak Probe is used the +ve push button must be selected instead of the HF push button.

2.2.8 DC Current Measurement

Measurement of current from 150 nA to 1.5 A f. s. d. is carried out as follows:-

- (i) Check set zero
- (ii) Select required current range
- (iii) Select appropriate input polarity +ve or -ve push button
- (iv) Connect test leads to source

The voltage drop and internal resistance of the FET Multimeter when used as an ammeter is shown in Table 2.1.

The Type 54461-021 Current Shunt supplied as an optional accessory (see Chapter 2.3 (f)) will increase the current measurement capability of the FET Multimeter up to 150 amps AC/DC.

Range f. s. d.	Voltage Drop at Max. Meter De- flection	Internal Resistance or Impedance as Measured on Input Socket	
		DC Resistance Ω	Impedance Ω at 1 kHz
0.15 A	5 mV	31.6 k	31.6 k
1.5 A	50 mV	31.6 k	31.6 k
15 A	5 mV	316	316
0.15 mA	50 mV	316	316
1.5 mA	5 mV	3.17	3.17
15 mA	50 mV	3.17	3.17
0.15 A	5 mV	0.09	0.09
1.5 A	50 mV	0.09	0.09

Table 2.1 Voltage Drop and Internal Resistance of the FET Multimeter when used as an Ammeter.

The shunt resistance is 1 milliohm $\pm 0.5\%$. The FET Multimeter measures the voltage drop across the shunt resistance using ranges 5 to 150 mV only.

The effective additional current ranges are as follows:-

Current Shunt Range AC/DC	5 A	15 A	50 A	150 A
Voltage range	5 mV	15 mV	50 mV	150 mV

Table 2.2 Voltage Ranges used in conjunction with Current Shunt.

Measurement of current from 5 A to 150 A f. s. d. is carried out as follows:-

- (a) Connect banana plugs of FET Multimeter input lead to shunt box OUTPUT terminals.
- (b) Select appropriate voltage range as indicated in Table 2.2 above
- (c) Connect current source to be measured to the shunt terminals marked INPUT.

CAUTION

To avoid overheating and subsequent damage to the shunt resistors it is essential that when measuring current in excess of 15 amps the measurement period be restricted to 30 seconds.

2.2.9 Low Frequency Current Measurement

AC current measurement is carried out as follows:-

- (i) Check zero
- (ii) Select appropriate current range. Note that the frequency response varies with the range selected
- (iii) Select LF push button
- (iv) Connect the input lead to the source

Frequency response of the FET Multimeter used as an ammeter is 30 Hz to 20 kHz on the 15 μ A to 1.5 A ranges and 10 Hz to 1 kHz on the 150 nA to 1.5 μ A ranges. Typical response curves are shown in Fig. 2.3.

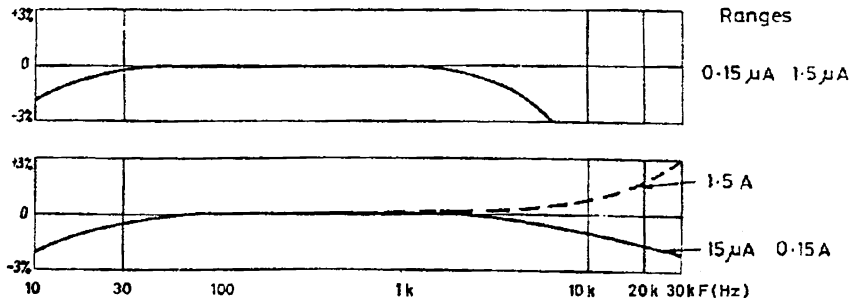

Fig. 2.3 LF Current Measurement Response.

The Type 54461-021 Current Shunt extends the current measurement capability of the FET Multimeter up to 150 amps, however frequency response is limited to 30 Hz - 1 kHz. In all other respects information contained in Chapter 2.2.8 relating to DC current measurement is also applicable to AC current measurement.

2.2.10 Resistance Measurement

To use the FET Multimeter as an ohmmeter proceed as follows:-

- (i) Select + Ω push button. A positive potential will be present at the red lead.
- (ii) Select the appropriate resistance range
- (iii) Short circuit the test lead
- (iv) Adjust the Zero R control for zero indication on the meter
- (v) Connect test leads to resistance being measured.

Note - By selection of the $\rightarrow\Omega$ push button the polarity of the test voltage will be reversed. This is particularly useful for forward and reverse bias measurement of semi-conductor devices.

Table 2.2 lists the maximum voltage, current and power applied to the 'unknown' resistance under test. For semi-conductor measurements the FET Multimeter should be used on the $\times 1 \text{ k}\Omega$ (or higher) ranges so that adequate driving voltage is available.

The $\times 10\Omega$ range is particularly useful for measurement of resistive components in transistor circuits, since the low applied voltage (24 mV) will not 'turn on' the transistors.

Ohmmeter Range	X10M Ω	X100k Ω	X1k Ω	X10 Ω
V max	1.2V	1.2V	1.2V	24mV
I max	0.012 μA	1.2 μA	120 μA	240 μA
P max	0.0036 μW	0.36 μW	36 μW	1.5 μW

Table 2.2 Maximum Voltage, Current and Power applied to Test Resistance.

2.2.11 dBm Measurement

The TF 2650 FET Multimeter dBm scale is a direct conversion from the voltage scale and is relative to 1 mW dissipated in a 600ohm load. (0.775 volts across 600 ohm).

The meter can be used to measure power dissipated in a load other than 600 ohm. In this case it will be necessary to determine the load impedance and then to apply the following correction (see Table 2.3) to the FET Multimeter dBm reading. The corrected reading will of course still be referenced to 1 mW.

Example - The FET Multimeter indicates 0.97 volts across a 300 ohm load. The uncorrected dBm scale reading is 2 dBm. Applying the correction factor from Table 2.3 the correct power reading is +2 dBm +3 dBm = +5 dBm (3.162 mW).

$$\begin{aligned} \text{By calculation } P &= \frac{V^2}{R} = \frac{0.97^2}{300} \\ &= 3.16 \times 10^{-3} \text{ W} \end{aligned}$$

Load impedance (ohm)	50	60	75	120	150	300	900
Correction factor (dB)	+10.79	+10	+9.03	+6.99	+6.02	+3.01	-1.7

Table 2.3 dB Correction Factor for common load values.

The correction factor for load impedances other than those tabulated above can be derived from the following expression:-

$$\text{Correction Factor (dB)} = 10 \log_{10} \frac{600}{Z} \quad \text{where } Z \text{ is load impedance in ohms.}$$

2.2.12 Temperature Measurement

The optional accessory Type 54451-131 Temperature Probe provides temperature measurement capability within the range -150°C to $+500^{\circ}\text{C}$. Proceed as follows:-

- (i) Connect the thermo-couple probe lead to the input socket
- (ii) Select +ve push button
- (iii) Select 50°C temperature range
- (iv) Locate push button on probe main housing (coupled to the BNC plug) and with the push button pressed adjust the ZERO DC control for a zero reading on the temperature scale.
- (v) On releasing the probe push button the FET Multimeter will indicate ambient temperature.
- (vi) To measure temperature at any point, select the +ve or -ve push button as appropriate and simply place the probe tip on that point.

CAUTION

Remember that the Temperature Probe tip is part of an electronic circuit and connection to a voltage point may cause damage to the probe circuits.

Temperature readings above 0°C are taken directly from the calibrated centre scales 0-5 or 0-15. Temperatures below 0°C may be measured at reduced accuracy
e.g. -50°C -10%, -100°C -15%, -150°C -15%. (See Fig. 2.8.)

2.3 ACCESSORIES

(a) Type 54451-081 High Voltage Probe

The HV Probe replaces the standard input leads providing a division ratio of approx. 1000/1 thus enabling the FET Multimeter to measure DC voltages of up to 50kV and AC voltages of up to 50 kV peak and 35,350 V RMS.

CAUTION

Maximum voltage measured must not exceed 50 kV peak.

When using the HV Probe accuracy is reduced to 5% of measured value in addition to the AC/DC accuracy stated in Chapter 1. 2.

The frequency response is also reduced to 40-60 Hz.

(b) Type 54451-091 RF Probe

The RF probe replaces the standard input leads extending the frequency coverage of the FET Multimeter up to 1000 MHz.

Accuracy is reduced to $\pm 5\%$ f. s. d. on 5 V and 15 V ranges and to $\pm 7.5\%$ f. s. d. on 1.5 V range (see Chapter 1.3 for frequency response).

CAUTION

When using the RF Probe the maximum voltage should not exceed 15 V RMS. Only the 1.5 V, 5 V and 15 V ranges should be used. The d. c. component must not exceed 250 V.

To ensure best VSWR the RF Probe should be connected to the source via the Co-axial T connector.

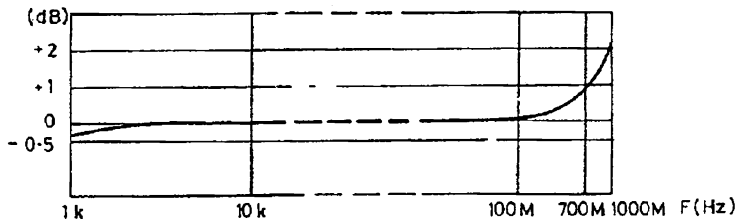
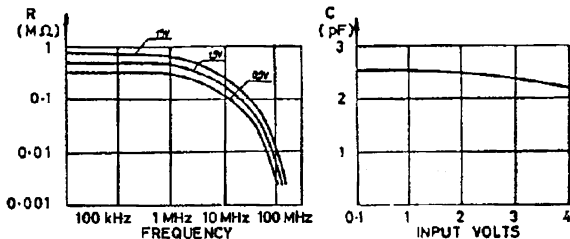

Fig. 2.4 Typical Frequency Response of RF Probe



Input Resistance of RF Probe as a Function of Level and Frequency

Input Capacitance vs. Input Level of RF Probe/ Measured at 1 MHz.

Fig. 2.5

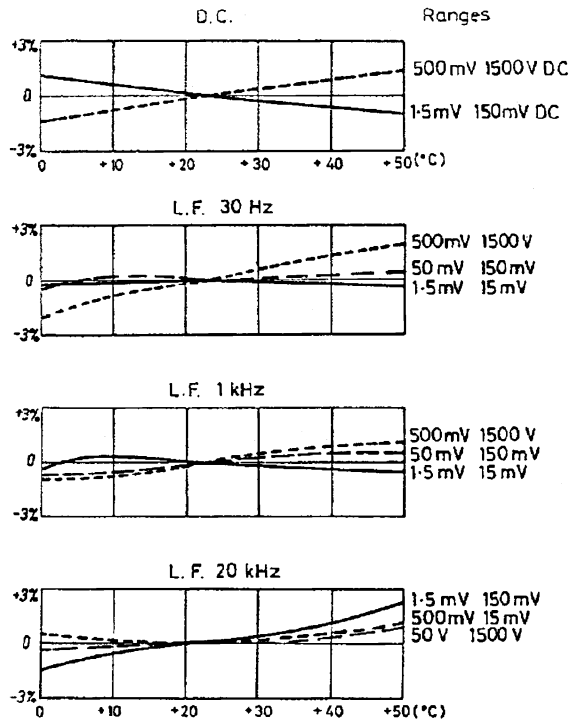

Fig 2.6 Voltage Measurement Characteristic as a function of temperature

(c) Type 54451-111 RF Voltage Divider

The capacitive voltage divider is used to extend the RF Probe measurement capability to 500 V peak. This accessory is constructed to fit over the RF probe nose and is a co-axial unit giving a nominal 100:1 division ratio together with a reduction of the input capacitance.

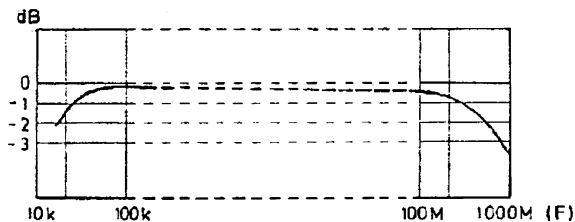

Fig. 2.7 Typical Frequency Response of RF Divider when fitted to Type 54451-091 RF Probe.

WARNING

Maximum voltage should not exceed 500 V peak. The 1.5 V and 5 V ranges should be used.

(d) Type 54311-051 Co-axial T Connector

The co-axial T connector can be fitted to the RF probe head to facilitate voltage measurement of 50 Ω co-axial. For this purpose both arms of the T are terminated in 50 Ω N type sockets. The response of the T connector is 1 kHz to 1000 MHz with an SWR of nominally 1.3 : 1 up to 500 MHz.

(e) Type 54451-101 Peak to Peak Probe 1.2:1 up to 1000 MHz.

The p-p probe allows peak measurements to be made on FET Multimeter ranges 5, 15, 50, 150, 500 and 1500 volts.

CAUTION

The maximum value of peak-to-peak input voltage at the probe head must not exceed 1500 volts peak.

(f) Type 54461-021 Current Shunt

The current shunt extends the FET Multimeter current measurement range up to 150 amps AC/DC.

WARNING

Measurement of current in excess of 50 A must be restricted to 30 second periods.

Current shunt resistance is nominally 1 milliohm.

(g) Type 54451-131 Temperature Probe

With the temperature probe fitted the FET Multimeter can measure temperatures in the range -150°C to $+500^{\circ}\text{C}$. (See Table 2.8).

(h) Type 54441-011 Mains Power Supply Unit

The optional power supply unit allows the FET Multimeter to be operated from any power line voltage 100 - 130 V, 200 - 260 V 40-60/400 Hz.

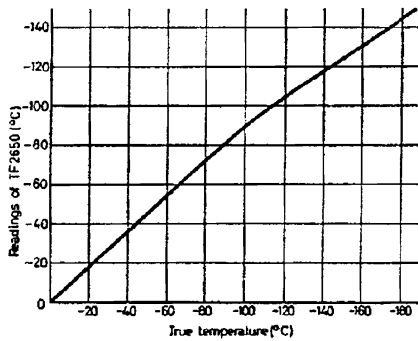
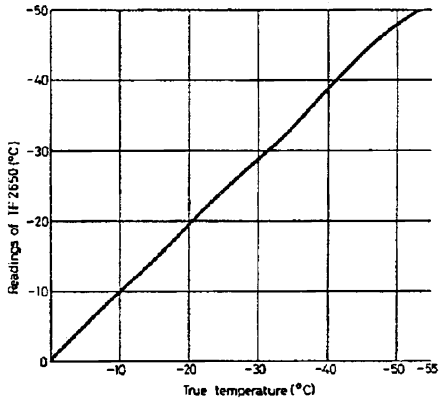

Fig. 2.8 Typical temperature probe error

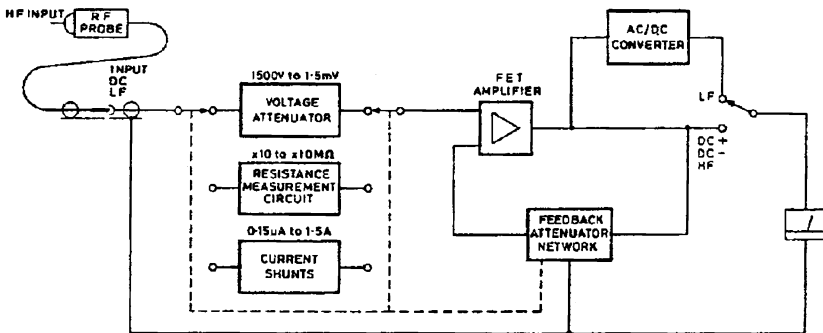

Fig. 3.1 FET Multimeter Block Diagram.

3.1 INTRODUCTION

General operation of the TF 2650 FET Multimeter can be explained with reference to the block diagram Fig. 3.1 and to the circuit diagram Fig. 6.3.

The signal to be measured is fed to the amplifier via one of the three function circuits :- voltage divider, current shunt and resistance measurement.

A twenty-five way function switch selects the amplifier input circuit and amplifier feedback network.

The AC to DC converter is selected only when the LF push-button is depressed. HF measurement is made by detecting the signal at source.

3.1.1 Measurement of AC/DC Voltage up to 20 kHz

Resistors R9 to R14 provide a 3 step attenuator (0-40-80 dB) thus limiting the

amplifier input level to 150 mV. Input resistance of the divider is $100\text{ M}\Omega \pm 1\%$.

When measuring AC signals Capacitors C1 to C5 provide flat frequency response and switch P1-2a modifies the resistor network to maintain the correct division ratio.

When measuring DC voltage the meter polarity can be changed by selecting '+' or '-' push-buttons.

3.1.2 Resistance Measurement

Resistance measurement is made by the series method. On the 1k, 100k and 10 M Ω ranges, input divider network R9 to R14 plus R37 and R38 constitute the series resistor. Battery B2 provides the source voltage and on these three ranges the applied voltage will not exceed 1.2 volts.

On X10 range R6 becomes the series resistor and the applied voltage is reduced to 24 mV by voltage divider R5/R7.

Provision is made for changing the polarity of the applied voltage to the unknown resistor by selection of the '+' and '-' push-buttons. It should be noted that the appropriate polarity is marked on the front panel and is the reverse of the push-button designation.

3.1.3 DC and AC Current Measurement

Current measurement is carried out by measuring the voltage drop across high stability resistors R1 to R4.

Values of the shunt resistors are such that the voltage drop on ranges 0.15 μ A, 15 μ A, 1.5mA and 0.15A is 5mV, whereas on ranges 1.5 μ A, 0.15mA, 15mA and 1.5A it is 50mV.

The polarity of the meter can be reversed by appropriate selection of '+' or '-' push-buttons.

3.1.4 AC/DC Amplifier

The voltage amplifier is integrated into a single component HLY 7006R (IC1) and consists of three directly coupled symmetrical amplifier stages. IC1 a-g. (See Fig. 6.1).

The first stage employs double field effect transistor T1. Input current is compensated over the entire operating range of the FET Multimeter by feedback circuit including D1 and potentiometer R28. A very high constant input impedance is therefore achieved and the out of balance voltage is kept very low. Input protection is provided by resistors R16 and R17.

R77 provides balance for the symmetrical dual FET T1 and also short-term compensation for ambient temperature fluctuations. The control is front panel mounted and designated ZERO DC.

The total amplifier configuration is within the feedback loop. The amount of feedback depends upon the range selected and is determined by feedback voltage divider R68 to R73. Frequency compensation is achieved by capacitors C26 to C32.

Front panel mounted R75 controls the amplifier gain during resistance measurement and is designated ZERO R.

3.1.5 AC to DC Converter

The AC to DC converter consists of diodes D4/D5, amplifier transistors T11, T12 and T13 plus smoothing circuit R59/C25.

The rectifier is introduced into the negative feedback loop which with the high gain of the amplifier provides an outstanding degree of linearity such that AC measurement can be made utilising the same metering circuits and scale as for DC measurement.

3.2 ACCESSORIES

The function of most accessories can be easily seen by reference to the appropriate circuit diagrams under Fig. 6.3. The circuit diagram of the Mains Power Supply Unit Type FET Multimeter is contained in the main circuit diagram Fig. 6.3.

3.2.1 Temperature Probe

The Probe consists of two major components - a Ni Cr-Ni thermocouple and an ambient temperature compensating circuit connected via a 1.5 meter lead.

The measuring head consists of a gold plated tip which is welded to the hot junction of thermocouple 1. The junction is housed in a metal shielded ceramic tube and handle. The direct contact between the junction and the tip, as well as the small dimensions of the tip (0.1 mm by 4 mm) ensure a low thermal inertia (2 seconds).

Cold thermo junction 2 is housed in a plastic box also containing the ambient temperature compensating circuit. This circuit is powered by a type MR7 1.35 volt mercury battery. Typical consumptions $6\mu\text{A}$.

The compensating circuit consists of a DC bridge (see Fig. 3.2) having resistance arms R3-6, and is connected in series with the thermocouple. Any change in ambient temperature is compensated by special copper wire resistor R4 together with thermocouple 2. The bridge components are selected so that at zero degrees C the bridge is in balance. This means that at $+20^{\circ}\text{C}$ the output voltage is $+0.63$ millivolts.

In the upper part of the plastic case there is a switch W, which allows the output terminals of the probe (i.e. input terminals off the TF 2650) to be short circuited and the TF 2650 correctly zeroed by adjusting the zero DC controls.

4.1 INTRODUCTION

This chapter contains information on preventive maintenance, performance checks and re-alignment procedure.

Performance limits quoted are for guidance only and should not be taken as guaranteed performance specifications unless they are also quoted in the Data Summary (Chapter 1. 2).

In case of difficulties that cannot be resolved with the aid of this manual, please contact our Service Division at the address stated on the back cover, or your nearest Marconi Instruments representative quoting the type and serial number of the instrument. If the instrument is being returned for repair, please indicate clearly the nature of the fault or the work you require to be done.

4.2 ACCESS AND LAYOUT

Access to the circuit is easily achieved as follows:-

- (i) Remove the battery cassette or power supply unit.
- (ii) Unscrew the four feet without removing the rubber inserts
- (iii) Remove the complete back cover leaving the front panel with the complete assembly attached.

4.3 PERFORMANCE CHECK AND RE-ALIGNMENT PROCEDURE

This check is simply the measurement of sources of known accuracy. Variable sources monitored by equipment of a higher order of accuracy ($\pm 0.5\%$), such as the TF 2671 Digital Multimeter, will suffice for most ranges.

For the ohmeter checks standard resistors for centre scale values will be required, i. e. 100 ohm, 10 kohm, 1 Mohm and 100 Mohm $\pm 0.5\%$.

- (i) DC VOLTAGE - Check zero, then apply regulated voltage adjusted for full scale values for each range and check the meter accuracy.
- (ii) AC VOLTAGE - Adjust AC source to 1.5 mV $\pm 0.5\%$. With the FET Multimeter switched to the 1.5 mV range, adjust the input frequency between 10 Hz and 20 kHz and check the frequency response at full scale deflection.

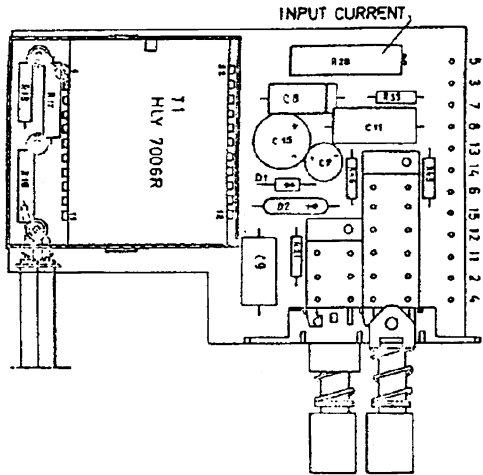

Fig. 4.1 Amplifier PCB (B-31-2005) Layout.

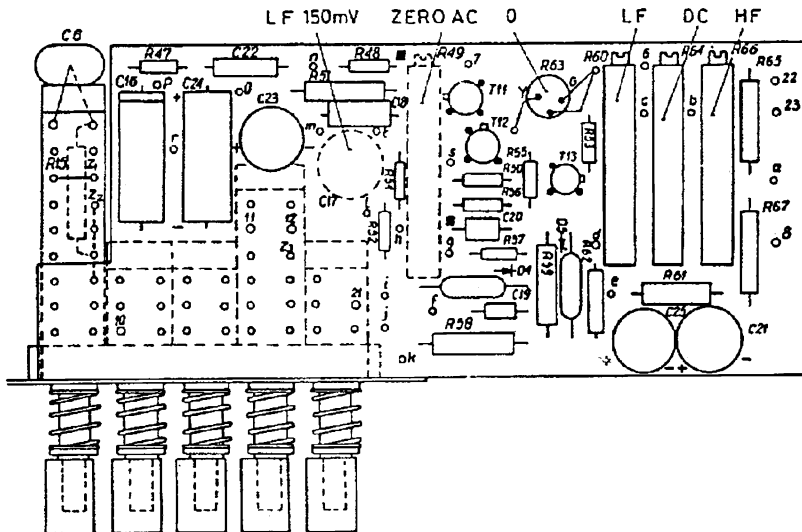

Fig 4. 2 Converter P.C.B. (B-31-1504A) Layout

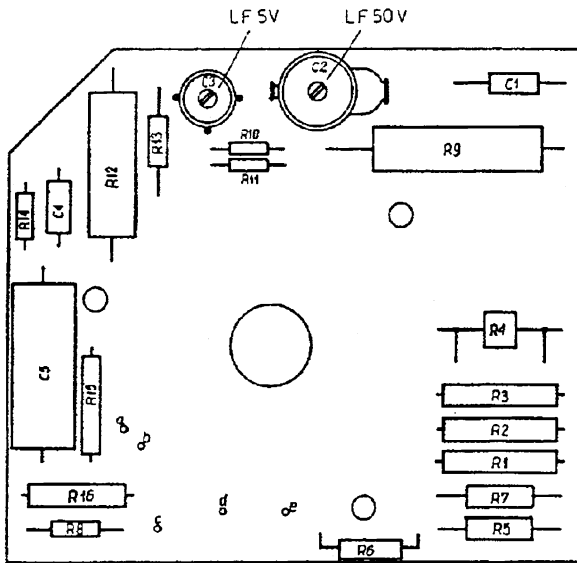

Fig 4.3 Input Divider (Rotary Switch) P. C. B. (B-31-1549)

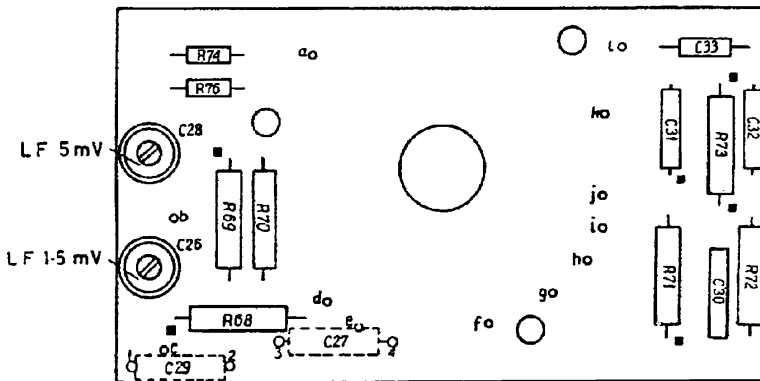

Fig 4.4 Feedback Divider (Rotary Switch) P. C. B. (B-30-2627A)

With the source frequency at 20 kHz, vary the source output level, checking the remaining full scale deflection values.

Switch the FET Multimeter to 5 mV range and with the source set to 5 mV $\pm 0.5\%$ check the frequency response between 10 Hz and 30 kHz.

- (iii) **CURRENT RANGES** - With the regulated DC current source of 0.5% accuracy set for 1.5 μ A output check for full scale deflection accuracy.

Adjust output for 0.15 mA, 15 mA and 0.15 A and check remaining ranges.

AC current accuracy is a function of the AC voltage circuits, therefore provided the current shunts are known to be correct in the DC current check, no special check is required of their AC function.

- (iv) **RESISTANCE RANGES** - Check ZERO R. Connect an appropriate centre scale value of resistor to the input terminals and check for meter accuracy.

4.3.1 Recalibration

Should the accuracy of the FET Multimeter not meet the specification (see Chapter 1.2) the instrument should be re-aligned as described below.

Due to the FET Multimeter design it is necessary to carry out all re-calibration in the sequence as listed, particularly for the AC voltage ranges.

- (i) **MECHANICAL ZERO ADJUSTMENT** - With the battery switched off, check the mechanical zero, adjusting the screw located immediately below the meter face.
- (ii) **ELECTRICAL ZERO ADJUSTMENT** - With input leads shorted and the FET Multimeter set to 1.5 mV DC + range check that the ZERO DC control has at least a 2 mV movement as indicated by the meter. Repeat this check with the DC - range selected. Select alternative values of R22 or R23 to achieve a 2 mV movement.
- (iii) **INPUT TRANSISTOR LEAKAGE CURRENT COMPENSATION** - Check that the electrical zero has been accurately adjusted. Remove the input leads and ensure that the input socket is electromagnetically screened (a BNC connector cap is ideal).

Adjust R23, located on the Amplifier Board (see Fig. 4.1) for a zero indication.

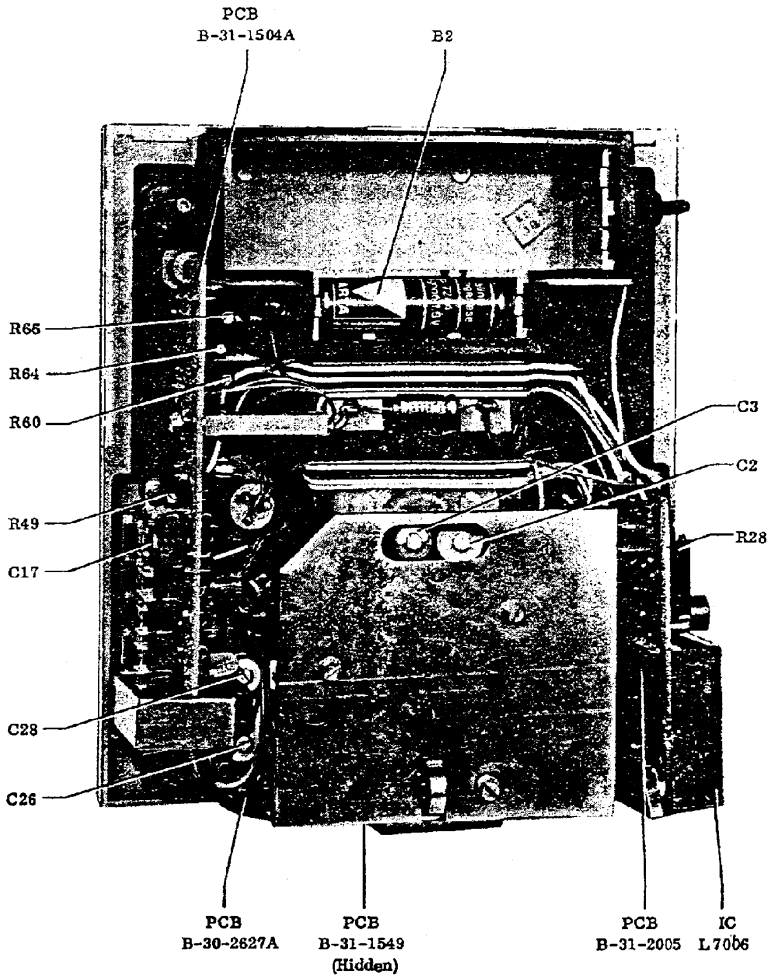

Fig 4.5 Board and Control Location

- (iv) AC/DC CONVERTER ZERO - Short circuit the input leads and with the FET Multimeter set to the 150 mV LF range adjust R49 located on the Converter Board (see Fig. 4.2) for a zero indication.
- (v) DC VOLTAGE CALIBRATION - If the check carried out in Chapter 4.3.1 (i) indicates instrument error which is not traceable to faulty input divider network, re-alignment is carried out with R64 located on the Converter Board.
- (vi) ADJUSTMENT OF AC VOLTAGE CALIBRATION - Overall sensitivity alignment is carried out on the 150 mV LF range by adjusting R60 located on the Converter Board.

Frequency response (at 20 kHz) is adjusted using trimmer C17 located on the Converter Board.

The following adjustments should then be carried out to achieve correct frequency response on the following LF ranges. All of the trimmers C2, C4, C26 and C28 are located adjacent to the range switch and are accessible upon removal of the instrument case.

- (a) 5 mV range, adjust C28
- (b) 1.5 mV range, adjust C26
- (c) 50 V range, adjust C2
- (d) 5 V range, adjust C4

- (vii) ADJUSTMENT OF VHF VOLTAGE MEASUREMENT RANGES USING TYPE 54451-091 RF PROBE - Apply 1 MHz 5 V RMS $\pm 0.5\%$ signal via the RF Probe. Adjust R66 located on the Converter Board for the correct full scale reading on the FET Multimeter.

4.4 PACKAGING FOR RESHIPMENT

In the event of the equipment being returned for servicing it should be packed in the original shipping carton and packing material. If this is not available, wrap the instrument in heavy paper or plastic and place in a rigid outer box of wood, fibre-board or very strong corrugated cardboard. Use ample soft packing to prevent movement. Provide additional support for projecting parts to relieve these of unnecessary shock. Close the carton securely and seal with durable tape. Mark the shipping container FRAGILE to ensure careful handling.

4.5 BATTERY REPLACEMENT

Three basic types of primary cells are in common use, they are zinc-carbon, alkaline-manganese and mercury.

The FET Multimeter uses the IEC R6 size (commonly known as AA Penlight, HP7, MN 1500). All three types are available in this size.

The choice of type is governed by cost, performance and contamination risk. The mercury battery has the best performance and least contamination risk followed by the alkaline-manganese cell, however, the zinc-carbon is by far the most economical having at least twice the watt hours/unit cost as the alkaline-manganese and four times that of the mercury cell. Leak resistant batteries such as the Varta 280 and Ever Ready C7 have very little contamination risk whilst retaining much of the economical advantages of the standard zinc-carbon cell. The Varta 280 is a zinc-chloride type with marginally less contamination risk than the Ever Ready C7.

Fig. 4.6 compares the zinc-chloride and alkaline-manganese performance and shows the effect of using the FET Multimeter with partly discharged batteries. It should be noted that with batteries in this condition the effects of low temperature will quickly reduce the supply volts below the specified limit. Use of alkaline-manganese and certainly mercury cells will reduce this effect.

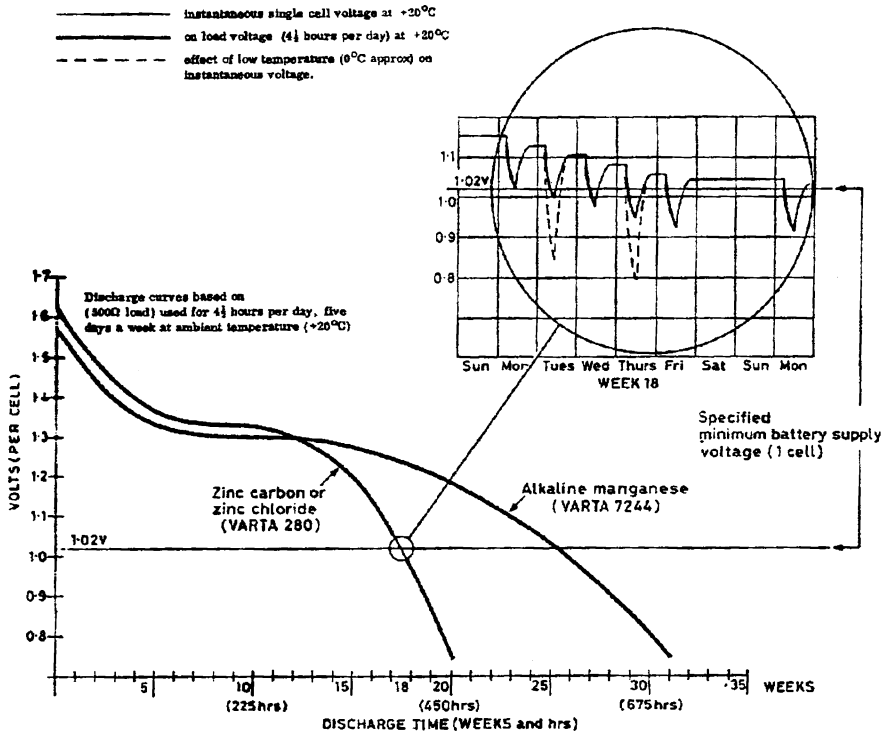

Fig 4.6 Battery discharge curves for an assumed FET Multimeter working week of 4½ hours per day, 5 days per week.

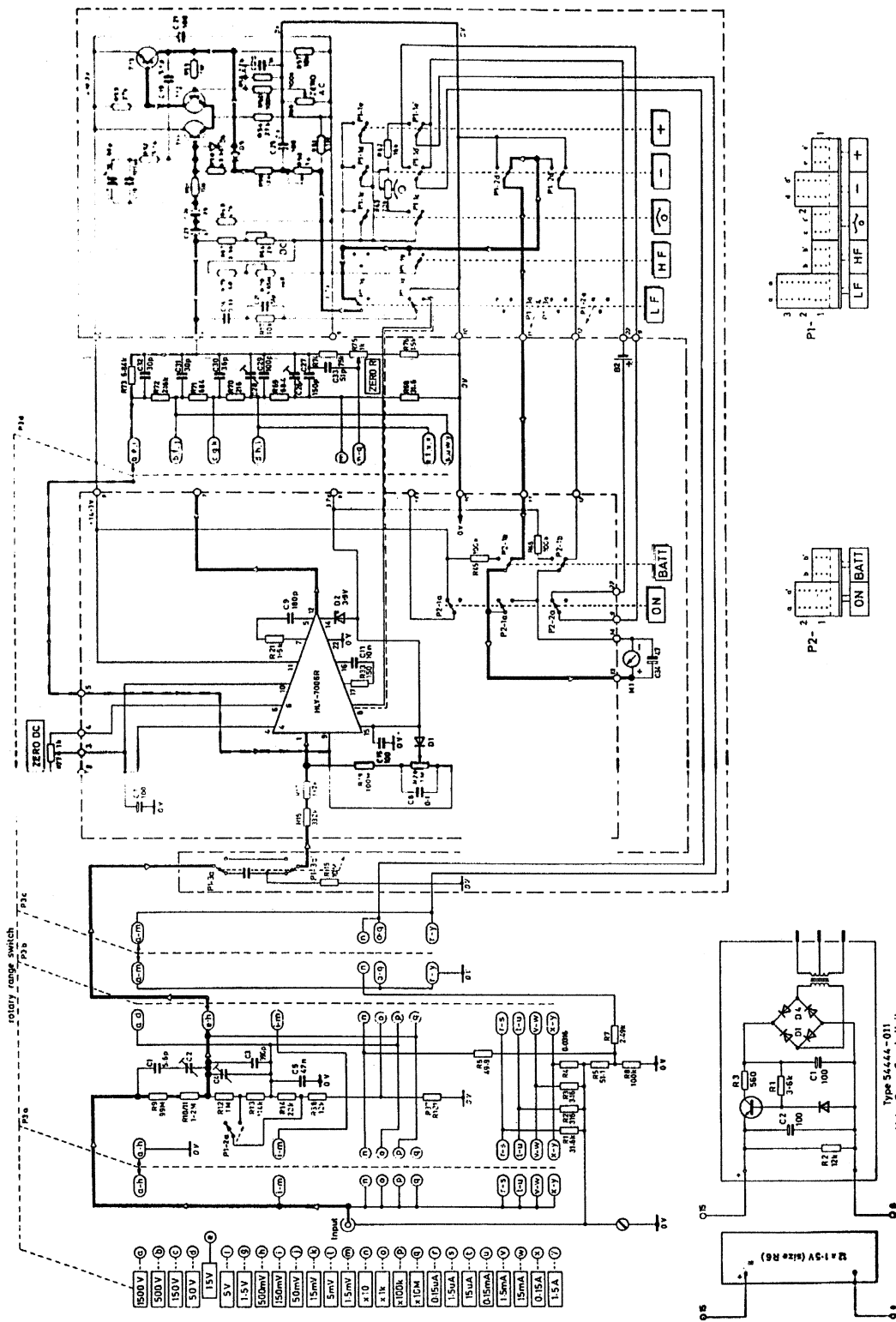
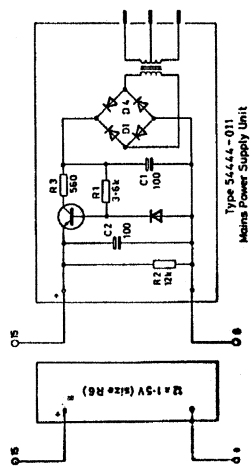

Fig.6.3 TF2650 Masteranger Multimeter Circuit Diagram.



Type 56464-011
Main Power Supply Unit

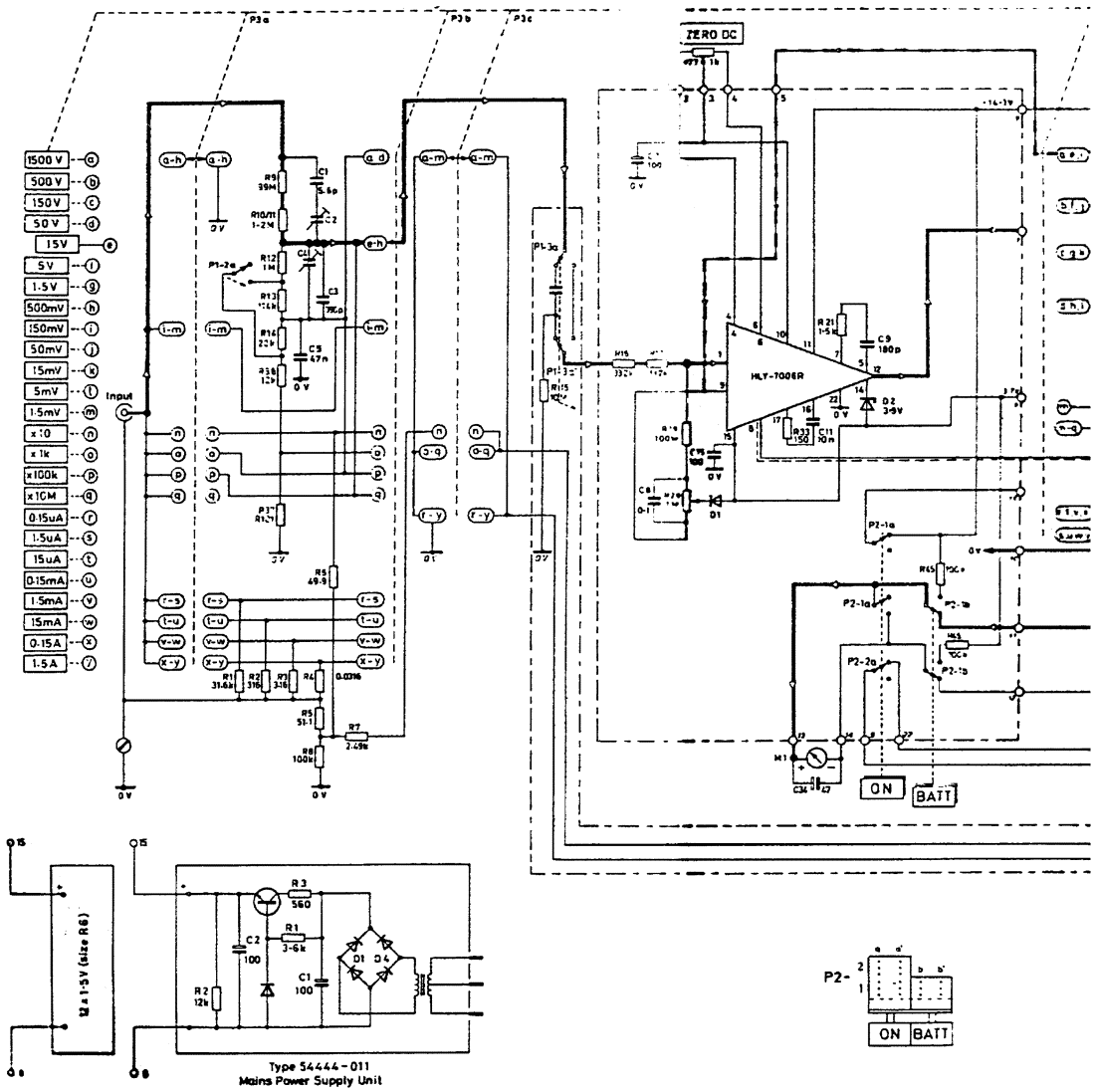
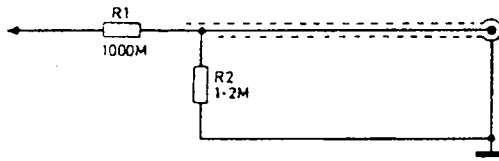
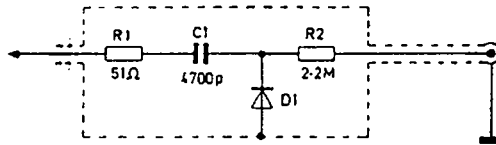

Fig.6.



Type 54451-081C High Voltage Probe.



Type 54451-091E High Frequency Probe.

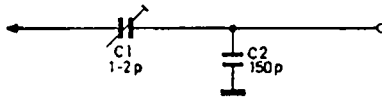

Type 54451-111D RF Voltage Divider.

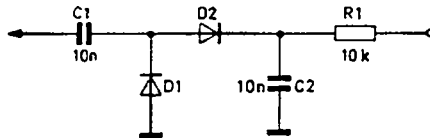

Type 54451-101L Peak-to-Peak Probe.

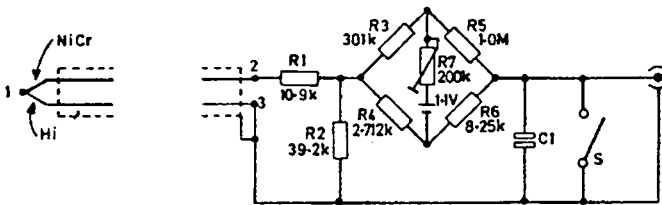

Type 54451-131Y Temperature Probe.

Fig. 6.2 TF2650 Accessory Circuit Diagrams